

1

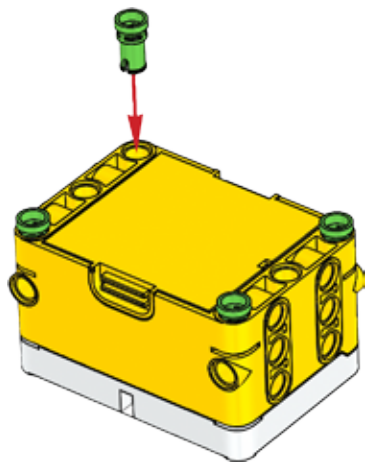

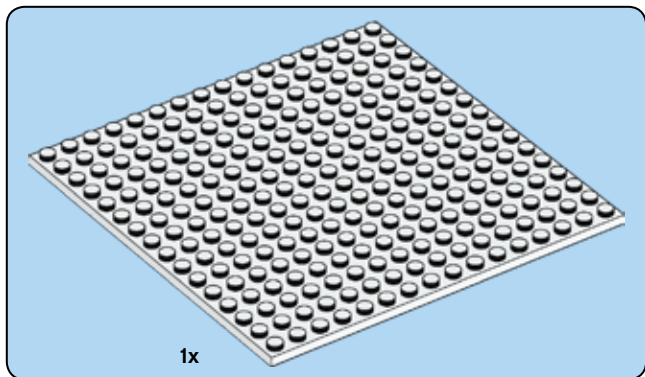

2

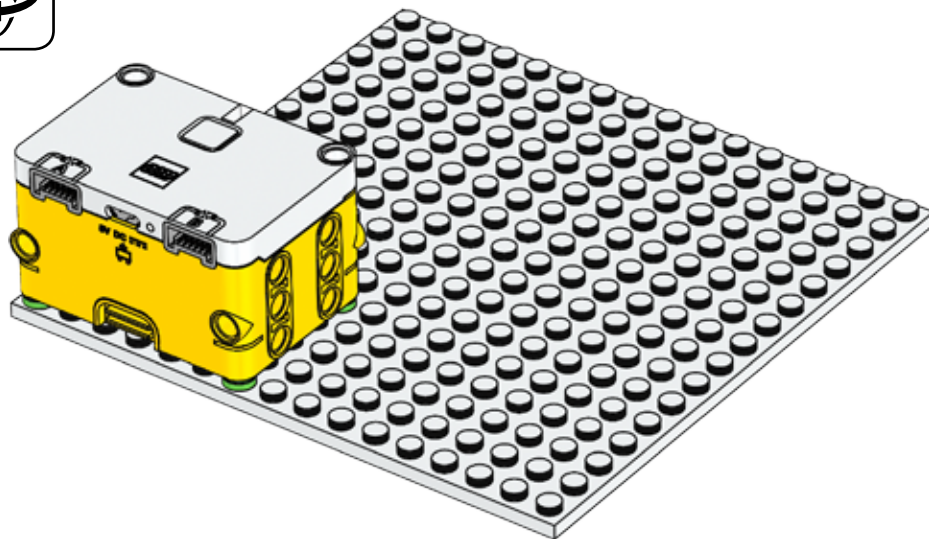



1x

3

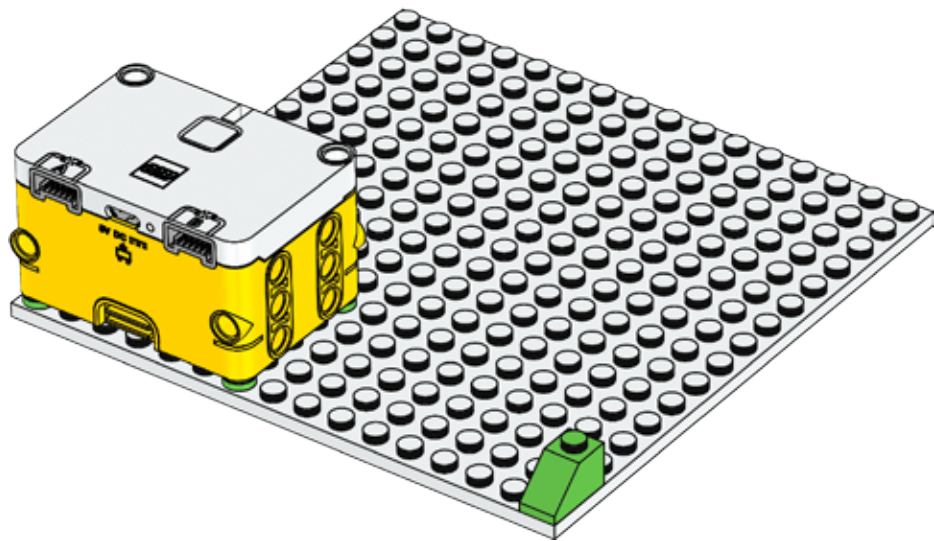

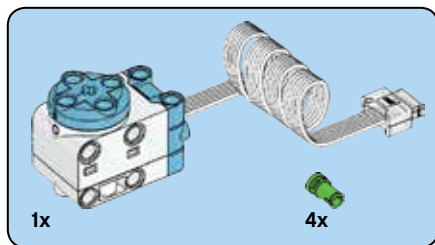

4

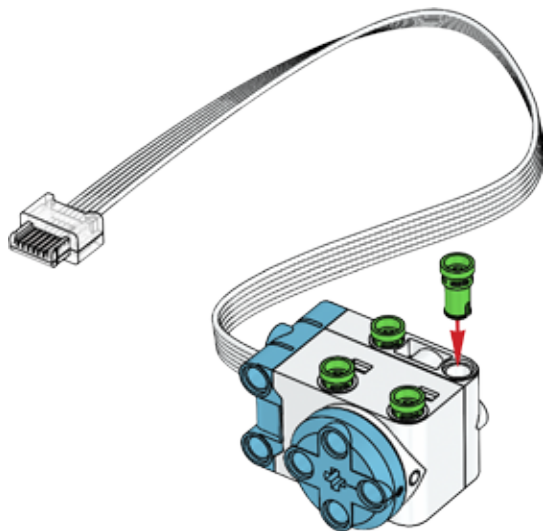



2x

5

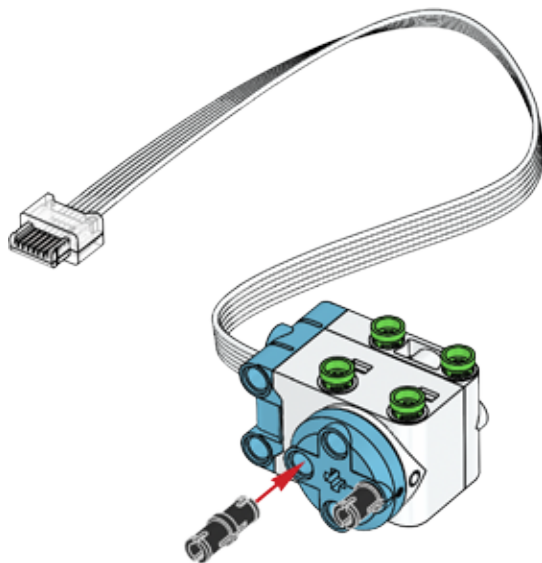

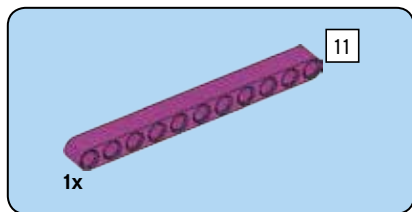

6

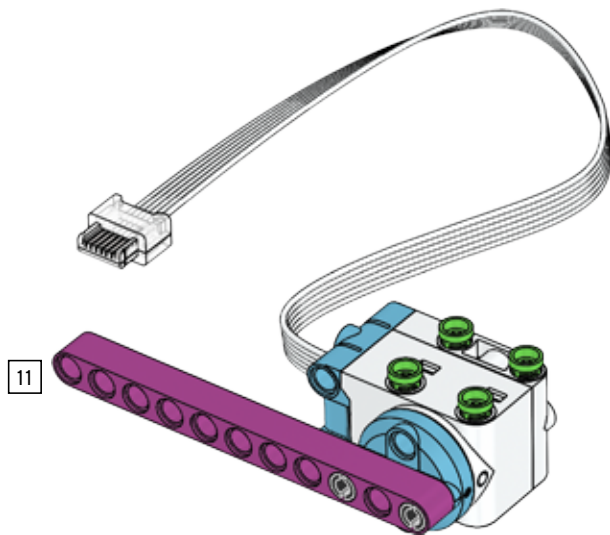



1x

7

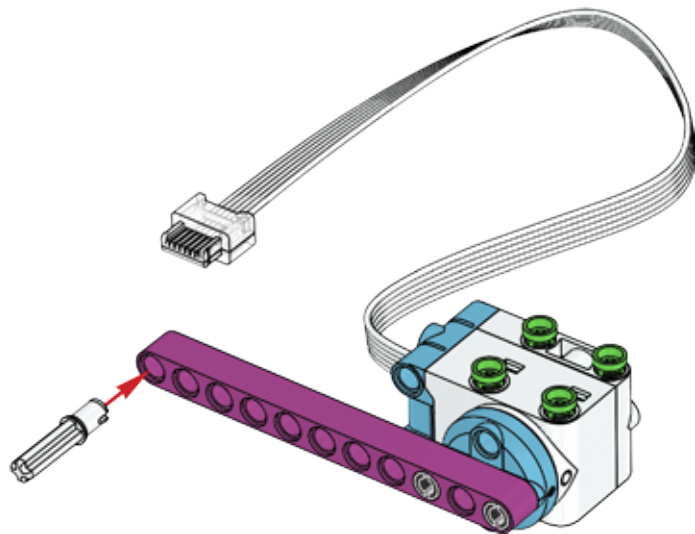

8

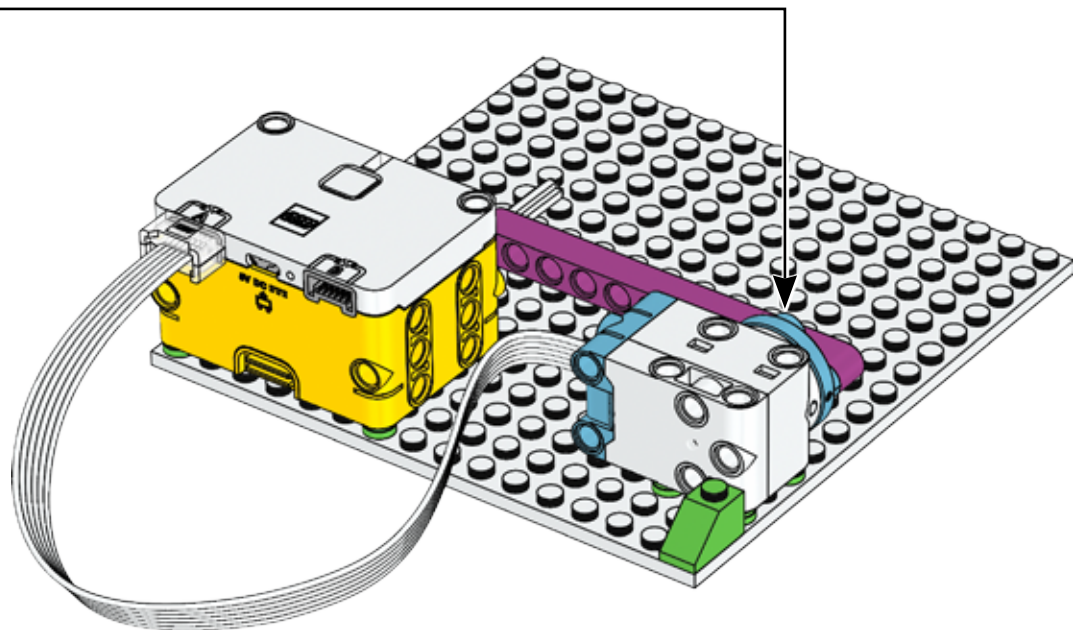



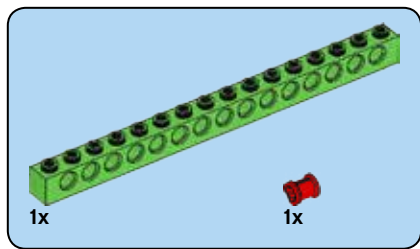

9

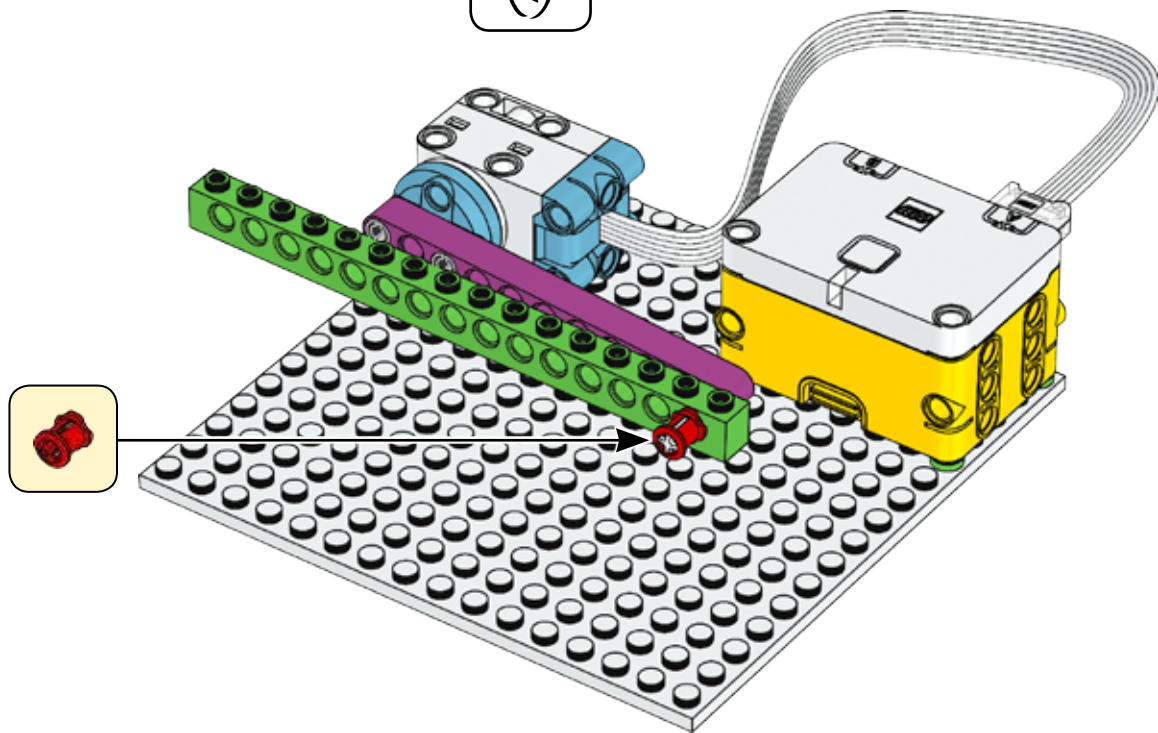
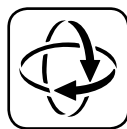

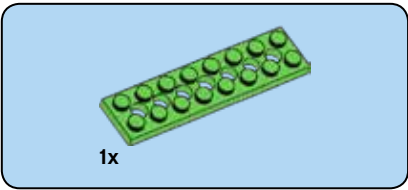

1x

10

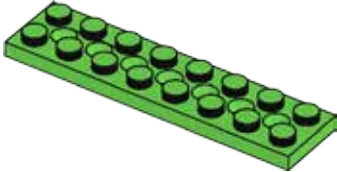



11

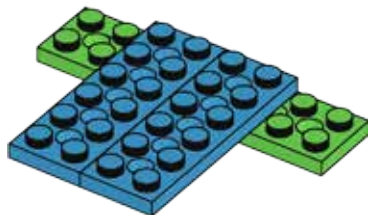

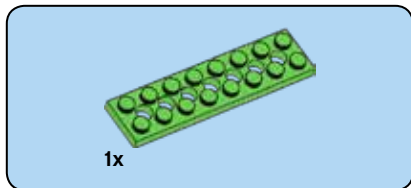

12

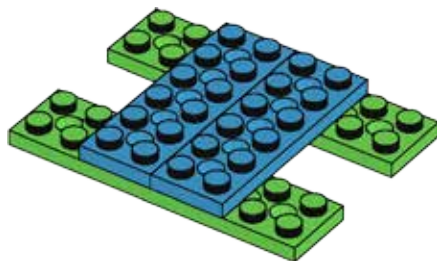

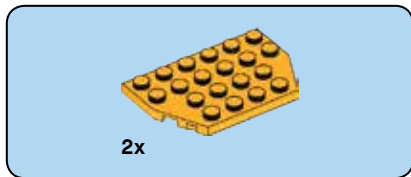

13

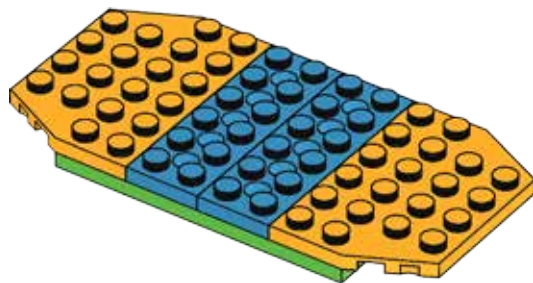



4x

14

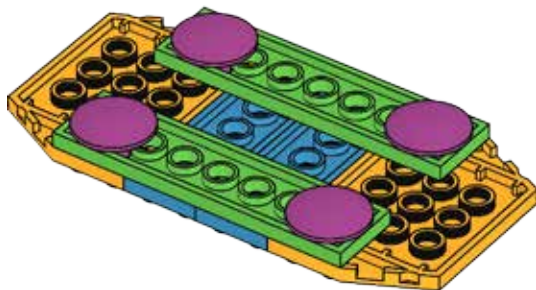

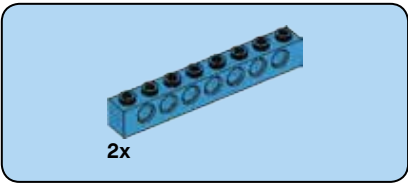

15

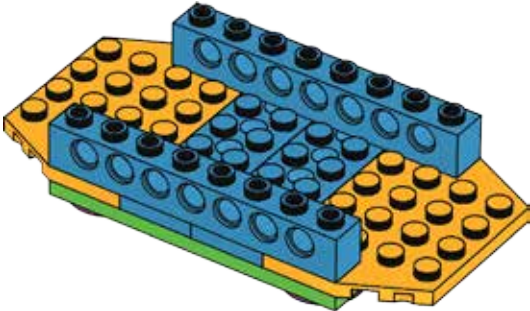



1x

16

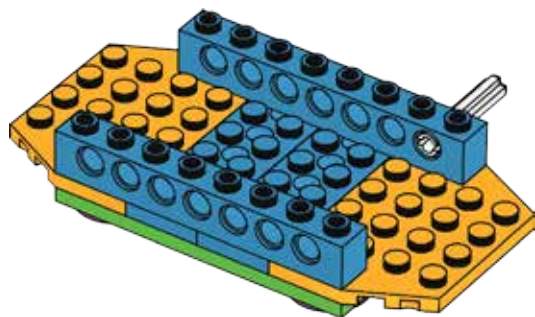





4x

17

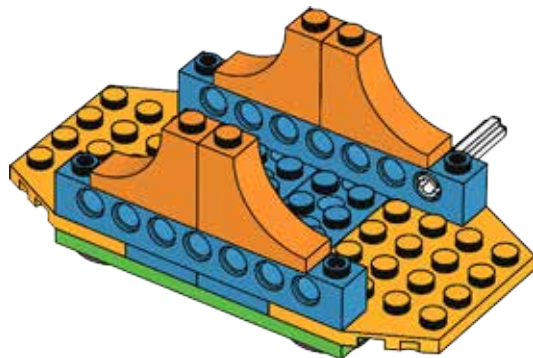



2x

18

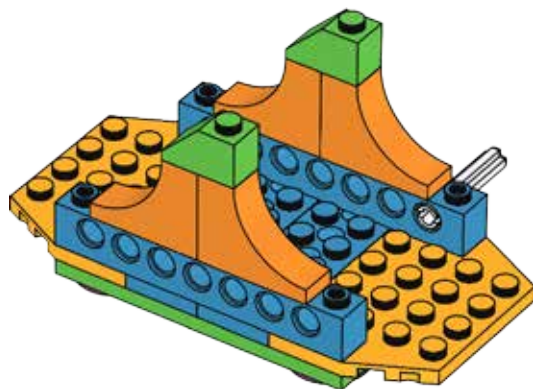



2x

19

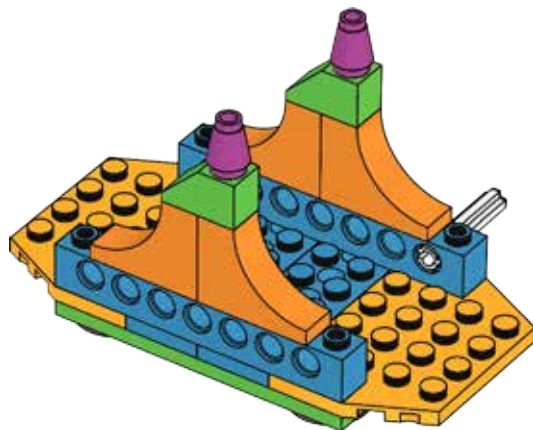



1x

20

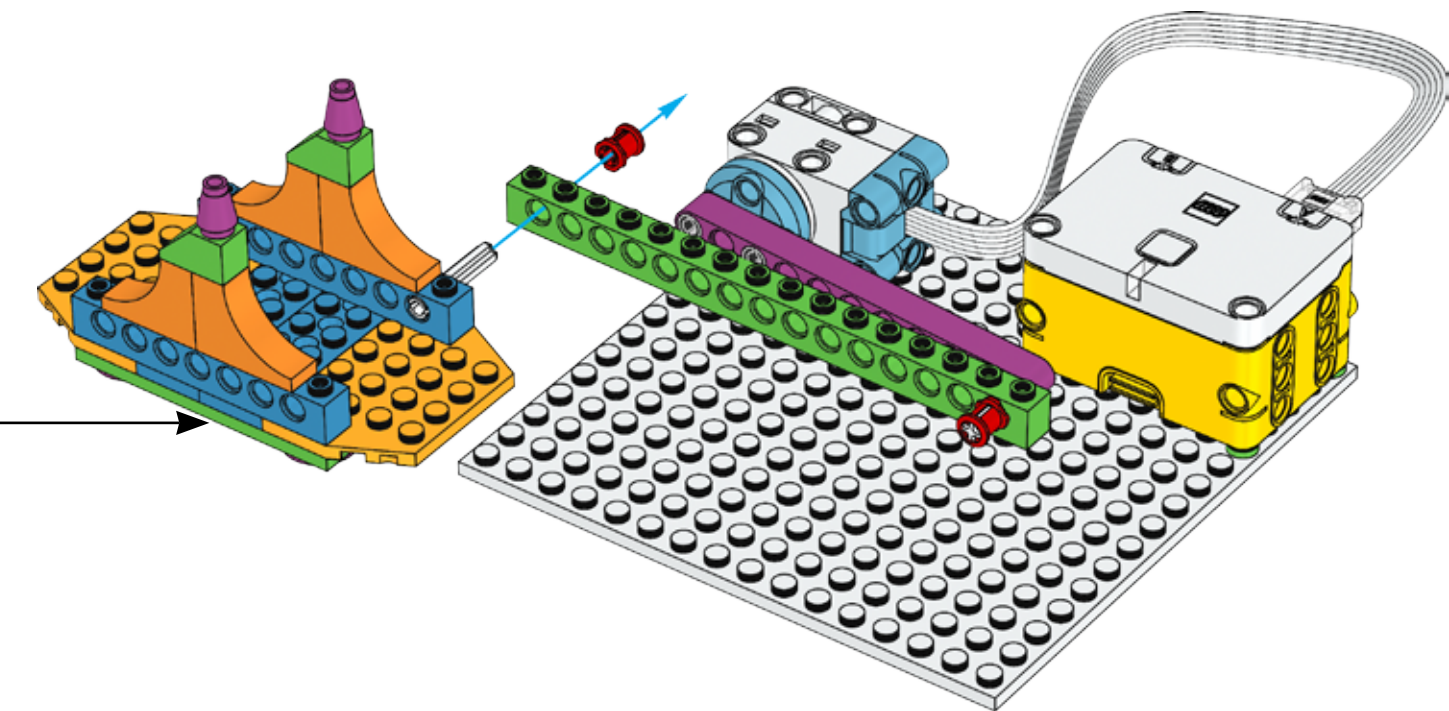

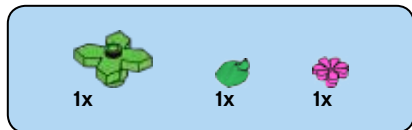

21

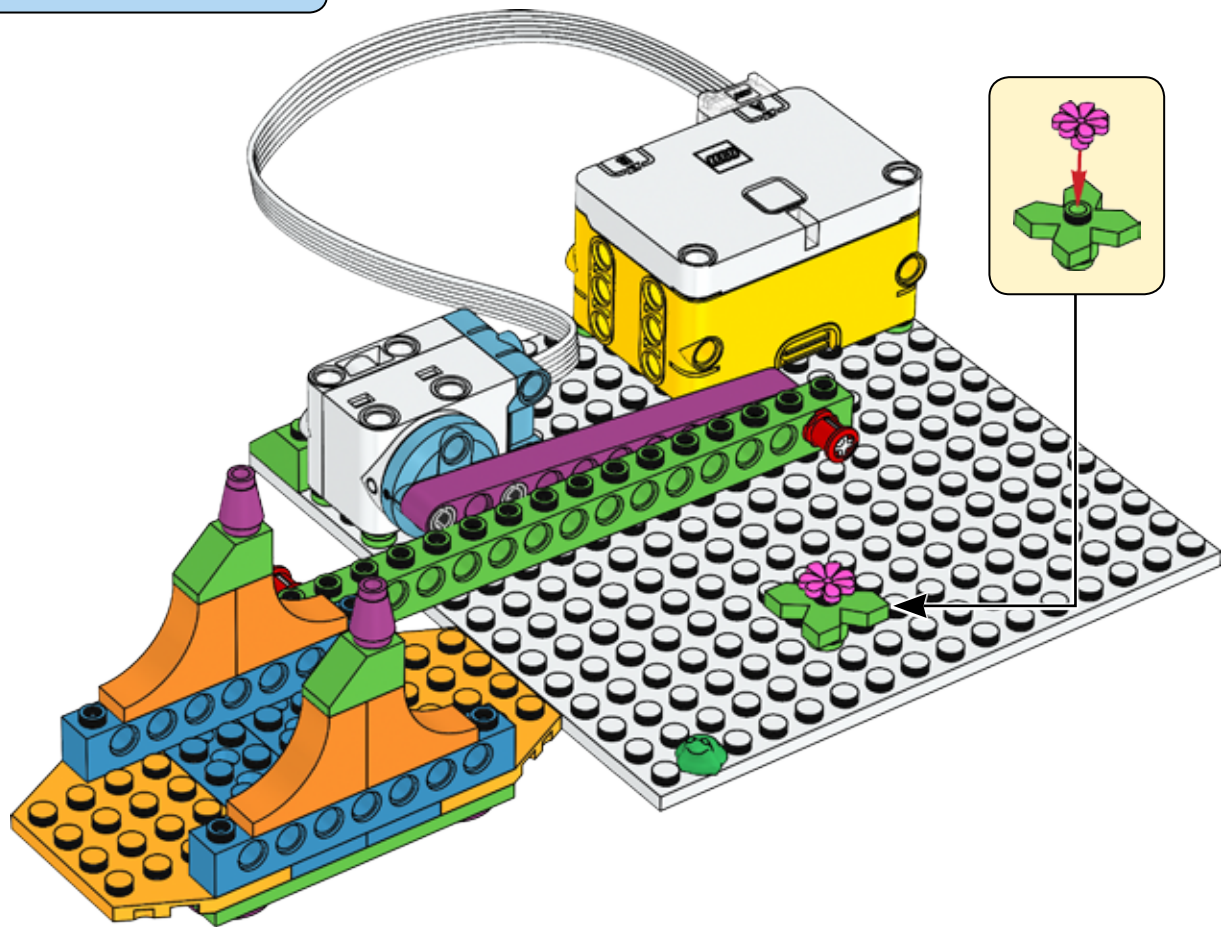

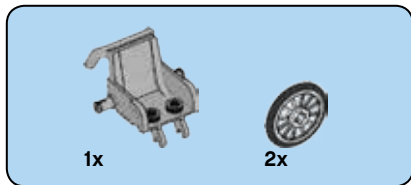

22

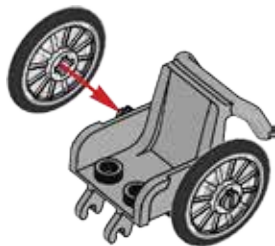



1x

23



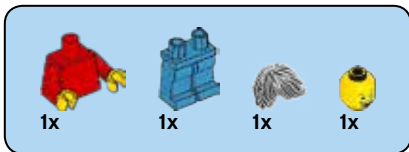

24

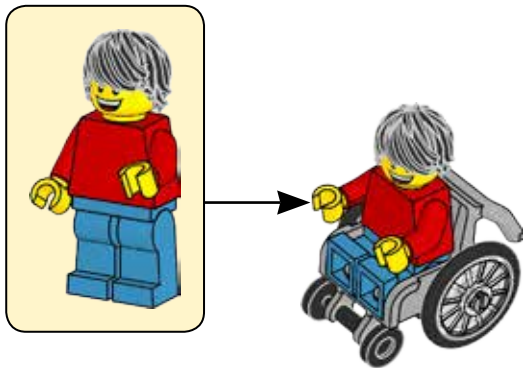



25

