

1 x

6



1x

1





4x

2



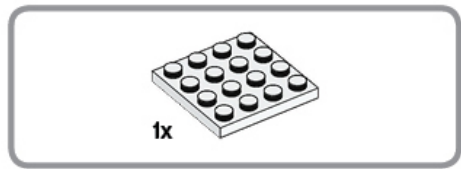

3



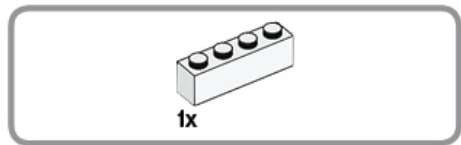

4



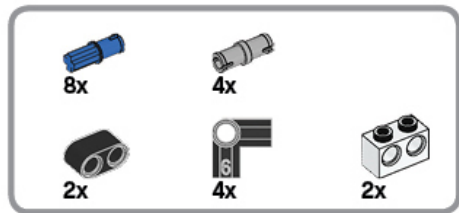

5

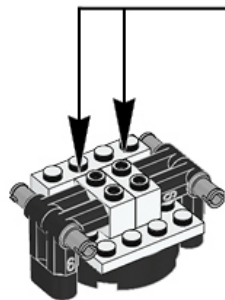
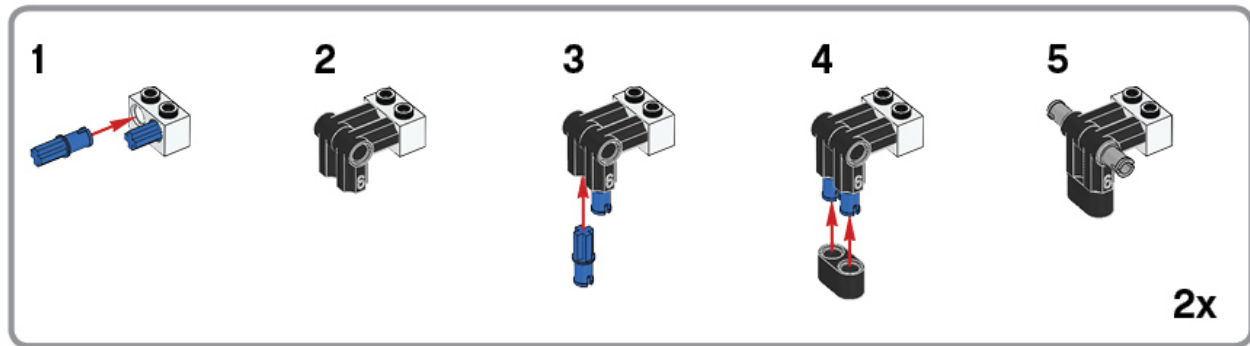

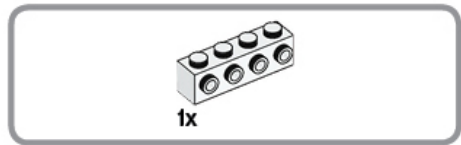

6



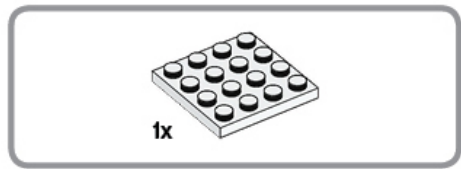

7





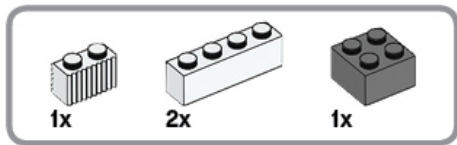

8

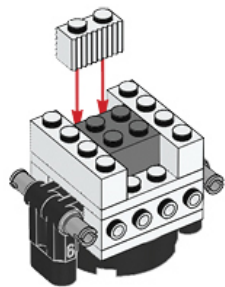

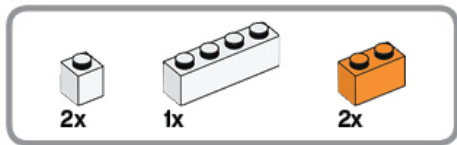

9

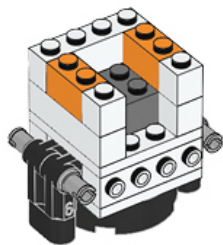

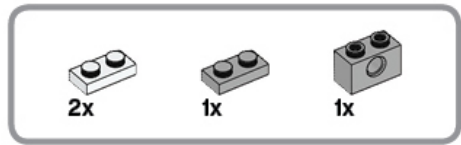

10

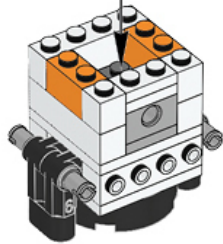
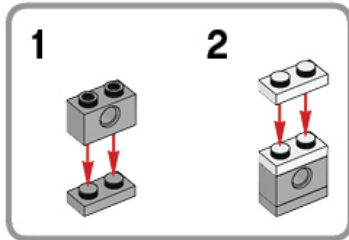



1x

11

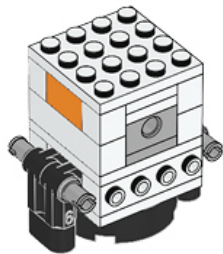



1x



4x

12

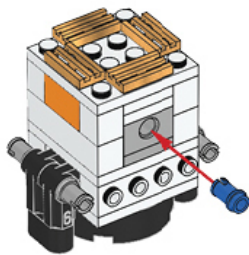



1x



2x

13

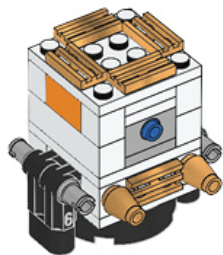

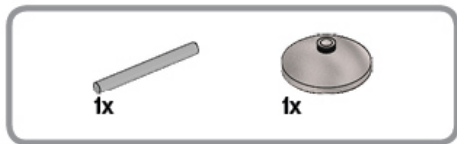

14

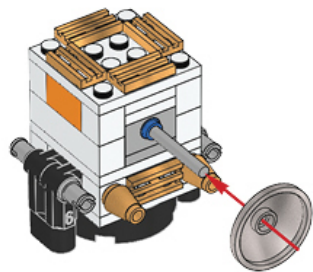

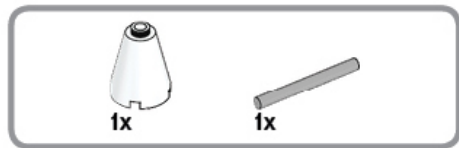

15

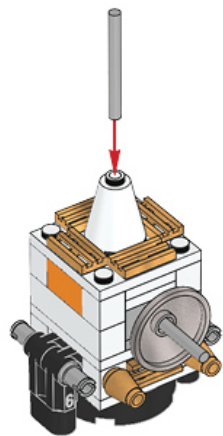



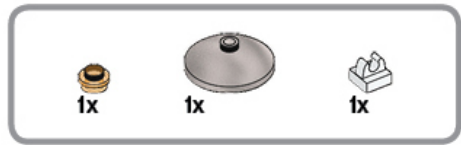

16

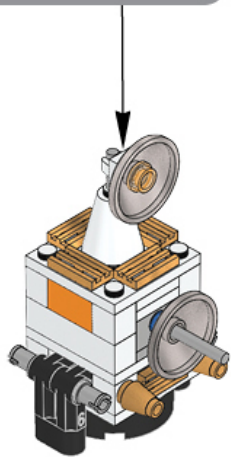
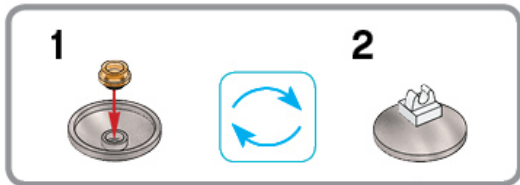

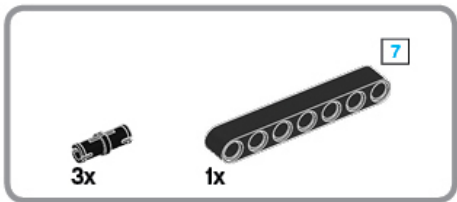

17



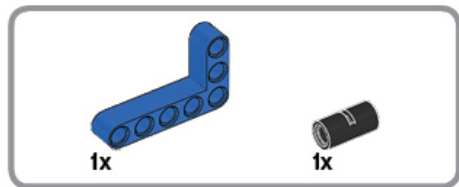

18

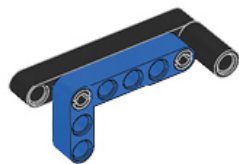



2x

19

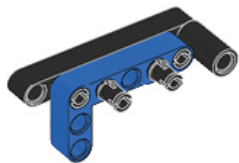

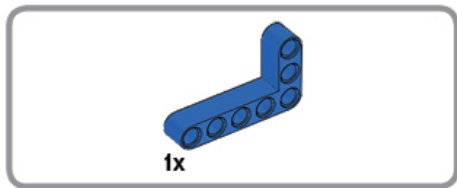

20

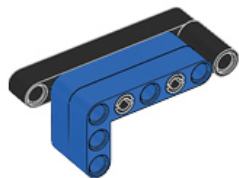



3x

21

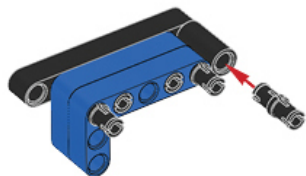

2x

22

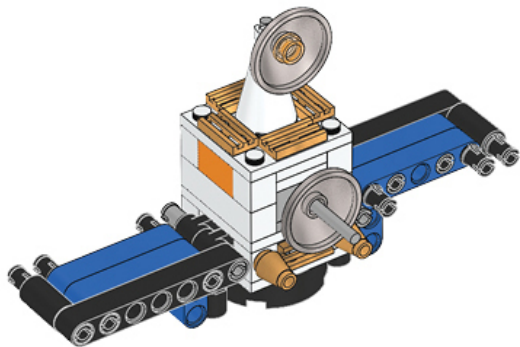

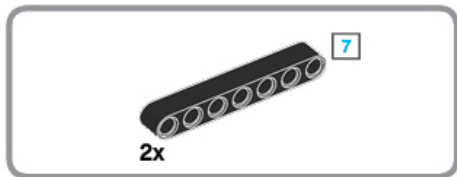

23

